

# LEEKY

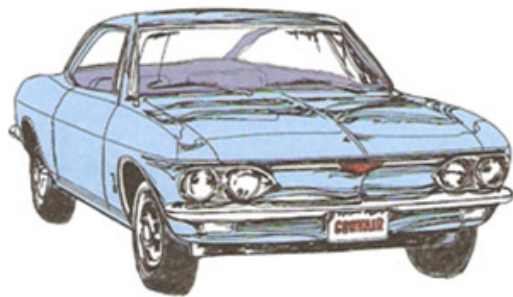

# SEEL

CORVAIR MINNESOTA NEWSLETTER

## President's Page

*We* made it thru another month of winter and with a couple more months to go spring will be here. This time of year finds me paging thru Clark's Corvair parts catalog making a wish list of everything I want to add to my Corsa. This is also the perfect time to get your car already for the upcoming driving season.

A big thank you to Bill and Carol Cook for organizing the annual Holiday Party at Latuff's Pizzeria. We had a good turnout with 44 members attending and also adding new member Dick Mickelson who lives in Plymouth. We had plenty of good food and fun, well done!

This February 20 the club will be touring the Commemorative Air Force Museum at Fleming Field in South St. Paul. This is the home of the Miss Mitchell B-25J bomber which served in the 310th Bomb Group, 57th wing of the 12th Air Force in North Africa and Italy completing 130 missions with no crew fatalities. I used to belong to the Commemorative Air Force and can tell you that the dedication of the members that have restored these planes is amazing. I hope to see you there.

Are your dues paid?

We don't want to lose you as a member!

## February 2016

We can continue to look for ideas for touring interesting places. In the works are touring a chrome plating shop in North Branch and a local body shop.

This month's membership meeting is back at the MUM and look forward to a good turnout.

*Jack Bacon*  
CMI President



SOLD! At Kissimmee Florida Auction: \$70,000.



2016 Corvair Minnesota  
Holiday Dues Party



Sorry Heather (but you only let me have 1 pic)!



# CMI 2016 Schedule



10 a.m., Feb 20th  
310 Airport Rd  
South St Paul, MN  
651-455-6942

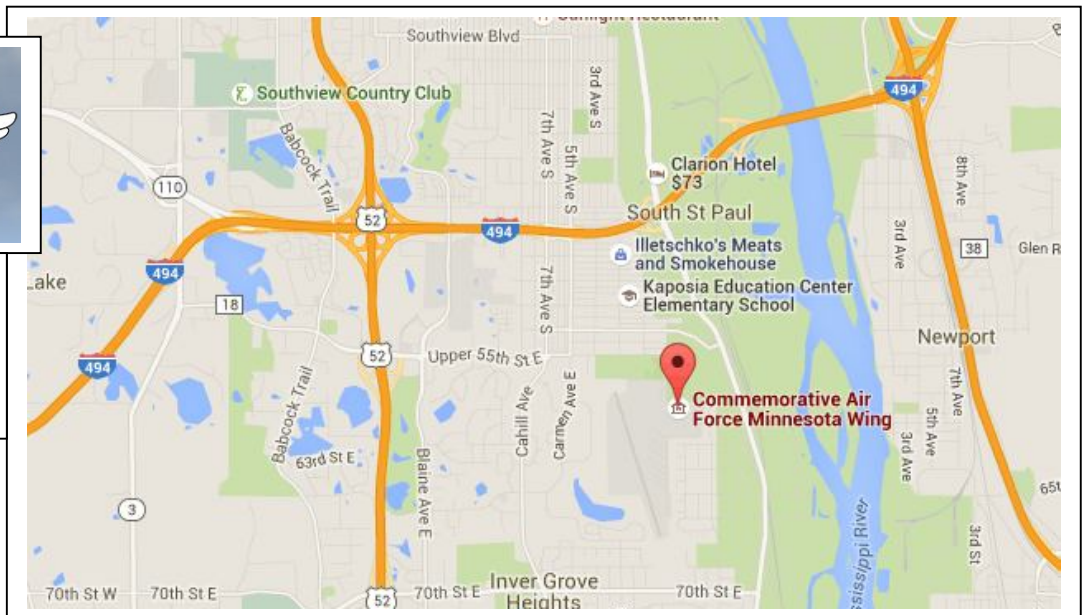

**Membership meetings are on the 2<sup>nd</sup> Tuesday of each month (unless otherwise announced)**  
**Board of Directors' meetings are on the last Thursday of each month (unless otherwise announced)**

**February** 09 Membership meeting – Messiah United Methodist (MUM)  
20 **Commemorative Air Force visit** – 10 a.m.; 310 Airport Rd, South St. Paul  
<http://www.cafmn.org/index.php/museum/visit-our-hangar-museum>  
25 Directors' meeting

**March** 15 Membership meeting – @ Twin Cities Auto Show – 2<sup>nd</sup> floor meeting room, 7 p.m.  
12-20 Twin Cities Auto Show, Mps Auditorium ( <http://www.tcautoshow.com/> )  
31 Directors' meeting

**April** 09-12 GSTA, Coliseum, State Fair Grounds ( <http://www.gstarod-custom.com> )  
12 Membership meeting  
28 Directors' meeting  
30 Pancake breakfast – Gabe's in the Park, 9-11:00

**May** Minnesota Inventor's Congress Invention & Idea Show – *has ceased to operate:*  
[http://www.twincities.com/localnews/ci\\_28932033/after-58-years-minnesota-inventors-congress-calling-it](http://www.twincities.com/localnews/ci_28932033/after-58-years-minnesota-inventors-congress-calling-it) ]  
01 Spring Extravaganza Car Show and Swap Meet, State Fairgrounds,  
( [www.gopherstatebuick.org](http://www.gopherstatebuick.org) )  
10 Membership meeting  
26 Directors' meeting



*From the Membership Coordinator-*

Please give a warm welcome to Dick Mickelson who joined at the Holiday Party. Dick lives in Plymouth and owns a 1965 Monza that he found in Nebraska. Hope to see you at the next meeting or event.

# FC/Early Rear Wheel Bearing

A few weeks ago I carried a real swing-axle bearing to the meeting along with a fake one that I had purchased many years ago. After pushing that bad-boy around on my shelf for years I finally decided to pitch it. It was already in the dump barrel when I got to thinking that I could put a new bearing into that guy's new/old housing: so I fished them out of the dump. Peter was over, so I said "Let's take that guy apart and put the new one in and also take some pictures". Good idea, so we ground off the rivets and tried to take the two halves apart. Grunt and groan! In the past I had separated bearing shells and they practically fell apart – this guy fought us all the way. When we got it apart we found a good bearing – from some other "non-CORVAIR" application – with a groove for a snap ring cut into its outer race. The two clam-shells simply slid onto that bearing and secured the snap ring. That would have been an alright deal if the bearing had barrel rollers. That's what made the fake CORVAIR bearing a really BAD bearing.

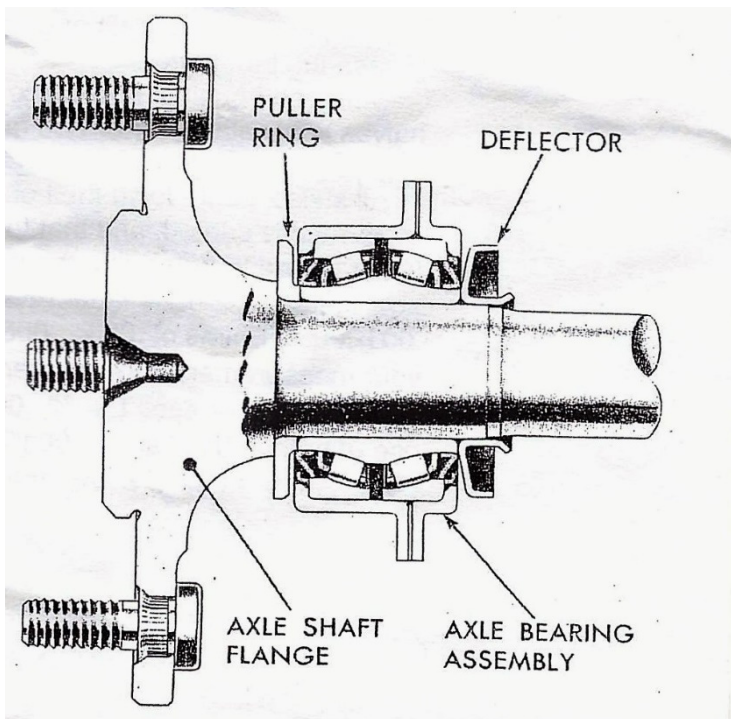

This is a view from the shop manual that shows the barrel rollers inside the CORVAIR rear wheel bearing...the one used by the Early and the FCs. There is a single race about an inch deep that is pressed onto the axle – the drawing shows no clearance in that dimension. There are also two half inch wide races that are trapped inside the axle-bearing assembly. Note that the two sets of roller bearings that are held between these races have barrel shaped rollers in them. Looking closely, you will see all of the races match those roller curves. This is what allows the axle to "swing", while its A-arm – the one that the bearing is bolted to - is also swinging. As they always swing in the same arc but not the same direction, they need the barrel-roller bearing.

## Early&FC rear wheel bearing

The stamped steel bearing shells are not all the same. When installing a new bearing you have to measure how well the new bearing fits and shim the

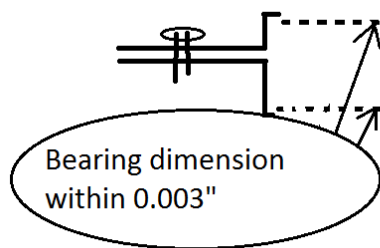

Two heavy (0.100") stamped steel fixtures riveted together so the bearing fits between.

When installing a new bearing - you clamp the two pieces together and measure the clearance between the pieces you have and the new bearing - shim to fit, within 0.003".

clearance: to tolerance. The thing you must remember when doing this measuring **is not to** put any grease on these parts **before** you measure the clearance...easy to forget, but if there is grease in there you could easily squander your 0.003" tolerance.

# ORDER YOUR CORVAIR APPAREL NOW !!

Our current supplier for apparel is Visions Embroidery of Buffalo. We have really nice quality clothing to choose from, and the prices are very reasonable. We usually have LG and XL in stock, but we can order whatever you want. **(UPDATED PRICES AS OF 8/1/15)**

T-SHIRTS : Gildan crew, heavy cotton heavy cotton (size S - XXL)	\$20.00
Colors : black, white, navy, red, ash	
SILKSCREENED T-SHIRTS : (size S - XXL)	\$15.00
Colors : slate blue, white, sapphire	
NOVELTY T-SHIRTS : (size LG & XL only)	\$20.00
SHORT SLEEVE BLUE DENIM SHIRTS (size S - XXL)	\$25.00
LONG SLEEVE BLUE DENIM SHIRTS (size S - XXL)	\$30.00
SWEATSHIRTS : Hanes crew neck 90oz heavy fleece (size S - XXL)	\$25.00
Colors : black, gray, navy, red	
POLOS : L. A. Loving Egyptian cotton (size S - XXL)	\$25.00
Colors : black, white, navy, red	
JACKETS (unlined) : Port Authority Classic Poplin (size S - XXL)	\$45.00
Colors : black w/tan	
JACKETS (lined) : White Bear 3-Season nylon (size S - XXL)	\$50.00
Colors : black w/gray fleece lining	
FLEECE VESTS : Port Authority Polar Fleece (size S - XXL)	\$25.00
Colors : black, navy	
CAPS : Low Profile, velcro adjustable	\$15.00
Colors : black, white, navy, red, slate blue	
VISORS : Low Profile, velcro adjustable	\$10.00
Colors : black, tan	
CORVAIR 50 <sup>th</sup> ANNIVERSARY LICENSE PLATE (two left)	\$20.00
CMI OVAL LOGO MAGNETIC DOOR SIGN (8 x 10)	\$5.00
CMI SELF ADHESIVE OVAL LOGO (8 x 10)	\$2.00
CMI OVAL LOGO IRON-ON PATCH (4 x 8)	\$5.00

- \*\* All clothing items are priced with CORVAIR MINNESOTA logo on the left crest
- \*\* If you want your first name embroidered, add \$5.00
- \*\* If you want the oval CORVAIR MINNESOTA logo embroidered, add \$25.00
- \*\* If you want to place an order, call Bill Cook at 612-940-9179



**SUNDAY, JUNE 5, 2016 • 9 AM - 3 PM**  
**MINNESOTA STATE FAIRGROUNDS - MACHINERY HILL**

**SPECTATORS**  
 \*General Admission: \$5.00/Adult  
 \*Children under 12: FREE

**EVENT INFORMATION**  
[www.gmcca.com](http://www.gmcca.com)  
[www.facebook.com/GMCCAssociation](http://www.facebook.com/GMCCAssociation)

**\*STATE FAIR RULES PROHIBIT:**  
 OPEN FIRES, BBQ's AND  
 ALCOHOLIC BEVERAGES.  
 PETS ON LEASHES ONLY.

**PARTICIPANT AWARDS FOR**

**BUICK • CADILLAC • CHEVROLET • CORVAIR • CORVETTE • CAMARO • CHEVELLE • NOVA  
 OLDSMOBILE • PONTIAC • SATURN /OTHER GM • CHEVROLET/GMC TRUCKS**

**Show Vehicles:** Gates open at 7am - Enter at intersection of Larpenteur Ave & Underwood.

**For Sale Vehicles:** Gates open at 7am - Enter at intersection of Larpenteur Ave & Underwood.

Pre-register for guaranteed space (until 10AM) & reduced entry fee.

**Swappers:** Gates open at 6am - Enter at Snelling Avenue Main Gate - All Makes of auto parts are welcome!

Please print legibly or use address label

**REGISTRATION FORM**

Name \_\_\_\_\_  
 Street \_\_\_\_\_  
 City \_\_\_\_\_ State \_\_\_\_\_ Zip \_\_\_\_\_  
 Phone (    ) \_\_\_\_\_  
 Car Club Affiliations (if any) \_\_\_\_\_

**GM SHOW VEHICLE**

Make \_\_\_\_\_ Year \_\_\_\_\_  
 Model \_\_\_\_\_  
 Preregister before May 15th - **\$10** per vehicle  
 Register after May 15th - **\$15** per vehicle  
 Includes Car, driver & one passenger per admission.

- SWAP SPACE - 15'x 20' Space**  
 \$10 each preregistered before 5/15  
 \$15 each after 5/15
- NEW PRODUCT VENDORS**  
 \$20 (In Display Area)
- FOR SALE AREA VEHICLES (All Makes)**  
 \$15 per vehicle preregistered before 5/15  
 \$20 per vehicle after 5/15  
**NO 'For Sale' signs allowed in the show area**  
**Make checks payable to and send pre-registration form to: GMCCA**  
**9632 Wyoming Terrace**  
**Bloomington, MN 55438**

The new bearing could be as loose as 0.017" so Clarks includes a set of shims that you put in between to take up that slop. When the bearing is shimmed to less than 0.003" (the tolerance is 0.001" – 0.003") you can grease them all up and complete the assembling (grease seal, etc.) then bolt (or rivet) the shells back together. Ready to install into your FC or Early. Slightly different procedure for the cast '64.



Here's a view of a fresh new barrel-roller bearing (FC size), ready to be installed. Next to the bearing is a set of shims (0.003", 0.006" and 0.012") for fitting this bearing into any set of used bearing shells.

Here on the bottom is that BAD bearing I told you about. Note the bolting flange only grabs the bearing by the snap ring; which may have been their cheap way to get around not having a bearing with the proper barrel-rollers.

Since I have FC bearings on my '64 Convert and on my Rampside I plan to have some good barrel-roller units assembled and available – on the shelf!

Fran



Fran screws up, **again**, but comes out SMELLING rosy!

My Rampside has a 140 engine, with a Saginaw 4sp and a modified 3.27 LATE differential (in the Early case).

The 140 has four carbs (I don't like the factory setup). I like to make the 2nd set of carbs show themselves at low speeds (where I drive) so I operate them independent of the primaries. I do that by switching them on/off with a button on my gearshift. There's a relay in back that is hooked to a pair of Chevy truck door lock motors (one on each of my 2ndaries). It is great fun to make my "Electric-2ndaries" kick in at 20 Miles an hour (at 3500 RPM)...without stepping on the gas! They give a great jolt of torque that is felt equally by all in the vehicle...especially since the button turns them off as fast as it turns them on. Blam up - - Blam down! Just like that. Great fun.

Now, here's where I screwed up. I had wired the relay to be activated when I grounded the wire in the shifter knob, thinking that I didn't want a hot wire on top of the shifter. Time passes and a few years of "great fun" turns into my present project of a new floor covering in the Rampside. I think I wrote about that in a recent note so we don't have to hash that over again, but here is where I got **lucky** ! One day as I was thinking over my new design, I take off the shift ball and lay it on the floor so I can put in my new Master Cylinder Access port. In order to unscrew the ball I had to disconnect the wire (from the switch that is inside of the shift-ball).



Since it was NOT A HOT WIRE I didn't even think that I was dropping it on the 'electric' floor. The floor now is not covered by the old rubber mat or the tar paper that was under it, but is it a good clean piece of steel connected directly to the Negative of the battery. As I said before – there I was "fat, dumb and happy", working on my new project of the floor, the M/C hole and the shifter boot, etc. One day I return to the project and my battery is dead. CRAP, I thought, probably left the key on or something. So I put the charger on it and later started it up to drive it to Menards for something and in the process I blip my 2ndaries - - no response! I figure I probably knocked off a wire in all of my cranking around (we did the LATE Holey gas tank project at this same time) so I wasn't worried at all. When I started to check the wiring to the 2ndaries I found they were all intact but the units mounted on each carb were **melted to death!** I had turned them on and left them on long enough to drain a full battery and melt two motors and NOT started a fire!!!

How lucky can you get!?!?!?

I have changed that wiring so that the relays do not work unless the key is ON. I got some new door lock motors and have mounted them with the old hardware and they work great – as before.

A wiser- thankful - man drives the Rampside now...and the shifter is divine!

Figures are: Shifter Knob with RED button, 2ndary carb with Motor installed and new M/C access port (cover not shown)

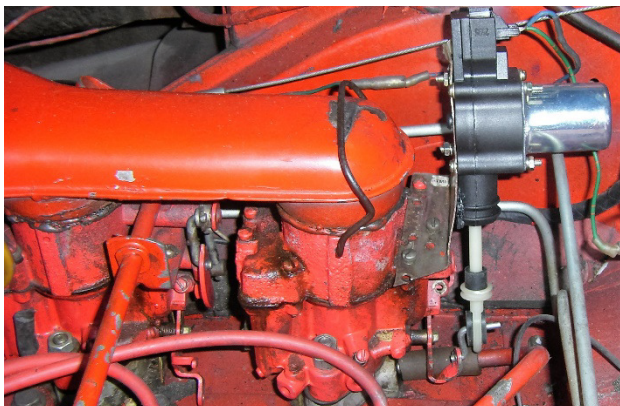

(8)

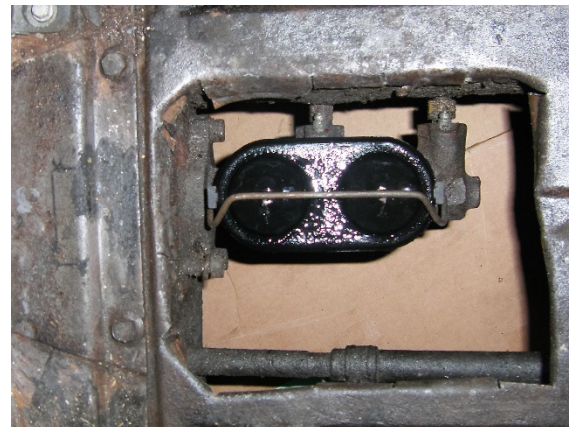



# CMI Classifieds

\*\*\*\*\*

**New:** Engine electrical harness, ball joints, Pertronix ignition; headers (110 and 140); custom exhaust; Wallen rebuilt starters generators and alternators; mufflers; rebuilt flywheels; new belly pan for late; crank and rod bearings.  
**Used parts:** complete engines, transmissions, differentials: call for parts – I have a large inventory.  
**Also:** 1969 110hp engine (runs great, sealed & pretty) Rare – aftermarket tube style early air grill – Solid flywheel  
**I also offer full time Corvair repair**  
 Gary Nelson 612-866-3247 or cell: 612-644-1258

\*\*\*\*\*

**Wanted:** I am looking for a number 1110310 distributor for a 95 HP 3 speed. I have a good 1110311 for a 95HP PG and I am looking to trade since the one I have in the car is not great, the bushing is worn. Jim Brandburg has looked over the one I have in the car and also the extra one I am looking to trade. Let me know if you know if anyone has one. Let me know and thanks for your help!  
 Jake Callahan [igottajob2@hotmail.com](mailto:igottajob2@hotmail.com)

\*\*\*\*\*

Trying to find the **1965 Corvair** I once owned.  
 I suppose converting a 1965 Corvair to a Corv-8/Corveight in the early 1970's is sacrilege to the Corvair purists, but I'm looking for help nonetheless, in trying to find my old corveight. It had a 327 corvette motor in the backseat, a Crown kit conversion. I sold it in 1975 and don't have the VIN, so know that I'm looking for a needle in a haystack, but thought I'd send this note to you in case someone remembers ever having seen the car and could provide a lead. If you could share this request and photo with some members, I'd appreciate it.

I've tried the MN DPS/DMV with no luck, since no computer records go back nearly that far, and paper records are not accessible. I've also posted a note on the corvaircenter.com site, and contacted the Corvair V-8 Registry. Last week I found the Mpls guy I sold it to, in West Virginia, but he doesn't have any records or the VIN, he had sold it to a Lake Street used car dealer after a year or two. Any other suggestions you might have to try to locate it would be appreciated. I suppose it's likely gone to a junk yard a long time ago.

Thank You Doug Carlson [corvette99ht@yahoo.com](mailto:corvette99ht@yahoo.com)  
 \*\*\*\*\*

I have a **1969 Corvair** two door coupe which is in very good condition. I would like someone to contact me if there is interest as I may sell it. I note that there were only 6000 Corvairs made that year in total. It is royal blue in color and runs great. Car is in Moorhead, MN  
 Gary H. Olson  
[garyholson@702com.net](mailto:garyholson@702com.net) 218-233-5130 Cell: 218-790-5130



**For Sale: BLUE AC Oil Filter**  
 High volume. Eight feet high! Inflatable promo. \$100  
 Fran Schmit (952) 929.9174 [schmfran@hotmail.com](mailto:schmfran@hotmail.com)

\*\*\*\*\*



**1965 Corvair** 110 HP 4 Speed. Nice driver, could use a paint job. Runs and drives good. Email with questions.  
<http://minneapolis.craigslist.org/ank/cto/5282513869.html>

\*\*\*\*\*

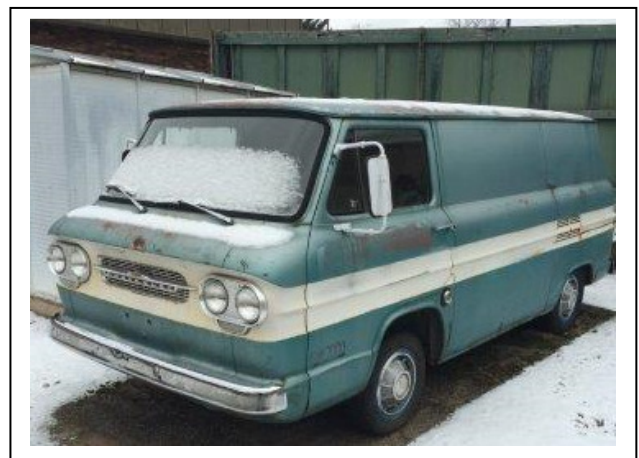

Saved from the crusher! **'61 Corvan** Needs New Home. New bonded title; rolling rubber 4-speed. Working locks and keys. \$1450 Call Bill Gautsche 715-828-9001

**WEBSITE:** <http://www.corvairminnesota.com/>

**OFFICERS:**

**PRESIDENT**

Jack Bacon  
195 Mallard Lane  
Loretto, MN 55357-9523  
763.479.6214  
jackchrisbacon@hotmail.com

**TREASURER**

Ray Alexander  
901 Woodlawn Ct  
Burnsville, MN 55337-3627  
651.334.8473  
fleetcap@aol.com

**VICE-PRESIDENT**

Jim Becker  
12930 37th ST  
Clear Lake, MN 55423-2024  
320-743-2889

**SECRETARY**

Chuck Johnson  
9632 Wyoming Terrace  
Bloomington, MN 55438-1640  
952.947.9106  
cljohnson99@gmail.com

**MEMBER COORDINATOR**

Jack Bacon  
195 Mallard Lane  
Loretto, MN 55357-9523  
763.479.6214  
jackchrisbacon@hotmail.com

**COORDINATORS:**

**TECHNICAL EDITOR**

Fran Schmit  
3370 Library Lane  
St. Louis Park, MN  
55426-4224  
952.929.9174  
schmfran@hotmail.com

**CLUB WEAR**

Bill Cook  
600 10<sup>th</sup> St SE  
Buffalo, MN 55313-5025  
612.940-9179

[wdcacook@yahoo.com](mailto:wdcacook@yahoo.com)

**HISTORIAN**

Cara Knauf  
401 West Street  
New Ulm, MN 56073-1527  
952.448.6983

**EDITOR**

John Herkenratt  
408 7th St S  
Hopkins, MN 55343-7722  
[Jherken1@netzero.net](mailto:Jherken1@netzero.net)

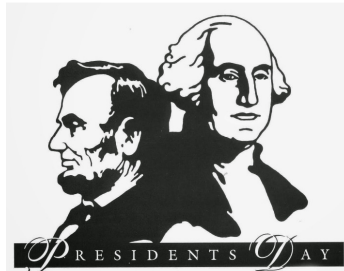

**Spot a 'Vair**



Corvair powered fishhouse – for sale in St.Cloud (Craigslist)

**CMI is a non-profit corporation, chartered with The CORVAIR Society of America. Send CORVAIR Minnesota's \$20.00 annual dues, payable by Jan 01, to the CMI Treasurer. Membership in CORVAIR Minnesota entitles you to the monthly newsletter, "The Leeky Seel", with free ads for members, a club window sticker, discounts on club activities, information on parts availability, and good advice on the preservation and enjoyment of the CORVAIR automobile.... Yeah!**

**THE LEEKY SEEL**

3370 Library Lane  
St. Louis Park, MN 55426-4224  
**TEMP – RETURN SERVICE REQUESTED**



*February meeting will once again be at the MUM*  
**\*\*\*REMEMBER- DUES ARE DUE\*\*\***